

ENG.NO. W0033-1010115

Rev版次	Revision note 變更內容	Date 日期	DR 制圖
A0	Original Release	OCT-29-10'	lijunhua
A1	Change the size	May,20,13'	Fanny_qu

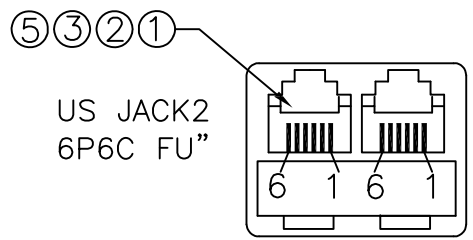
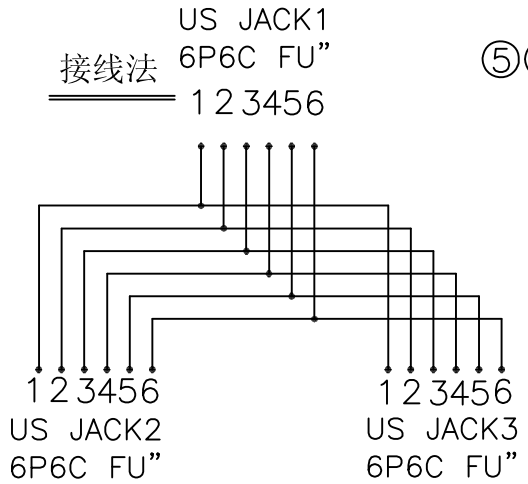
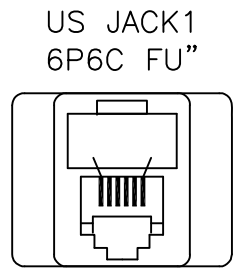
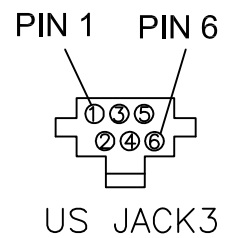
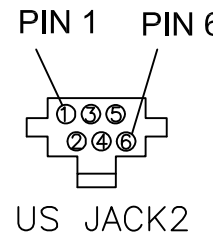
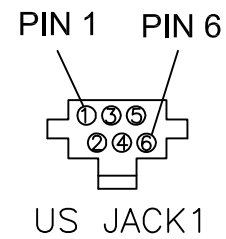
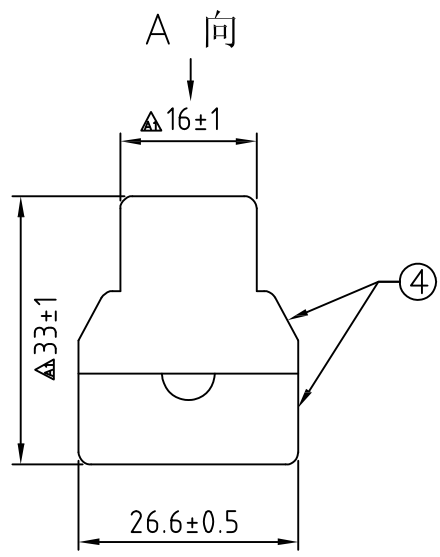
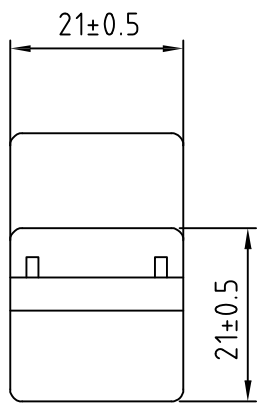
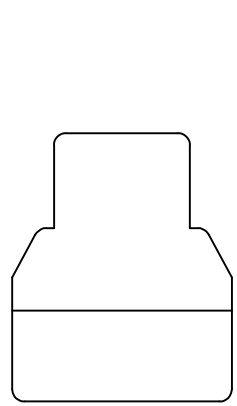

RoHS COMPLIANT

⑤	JACK 6PIN SUPPORT: ABS, IV1 COLOR	3PCS
④	HOUSING: ABS, IV1 COLOR.	1SET
③	JACK TERMINAL: BRASS.	18PCS
②	JACK PIN: 3U" GOLD PLATED.	18PCS
①	WIRE: 7/0.11*1.05 L=45mm	12PCS
ITEM	DESC	Q'TY

NOTE:
1. 100% OPEN/SHORT TEST.

威納電子 WINPOINT ELECTRONIC CORP. www.winpoint.com.tw		Title 名稱 1Plug TO 2 Jack Adapter 6P6C			
DR: 制圖 Fanny_qu	CHK'D 審核 Kenny_shi	APP'D 核准 Chen	REV. A0	UNIT mm	SHEET 1/1
PART NUMBER 威納料號 3296-303-6P6C	CUSTOMER P/N 客戶料號	DATE 日期 May,20,13'	GENERAL TOLERANCE 一般公差 MM X.X = ±0.38 X.XX = ±0.18 X.XXX = ±0.05 UNLESS OTHERWISE SPECIFIED		
DWG NO. 圖號 WP009-1010768-B	FILENAME 路徑 WP/009	SCALE 比例 N/A	ANGULAR ±3°		