

ENG.NO. W0033-1010109

Rev 版次	Revision note 變更內容	Date 日期	DR 制圖
A0	Original Release	Aug.27,09'	Xuzhihua

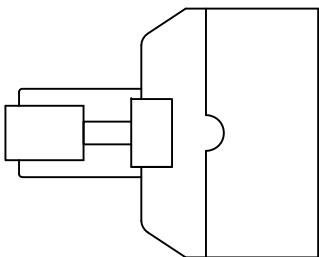

WIRING DIAGRAM

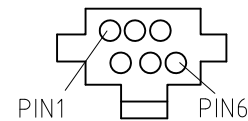
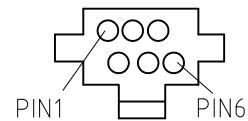
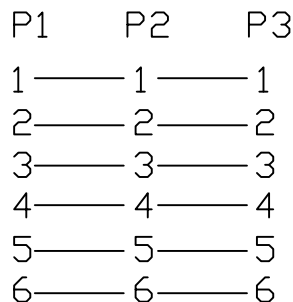

P2

P3

NOTE:

1. 100% OPEN/SHORT TEST.

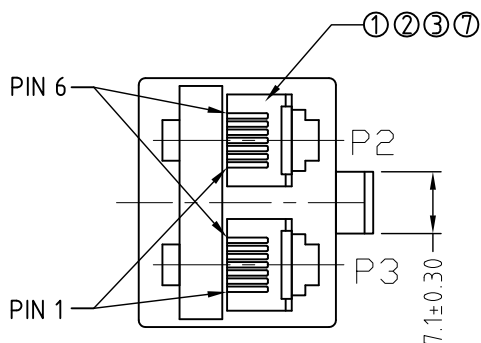
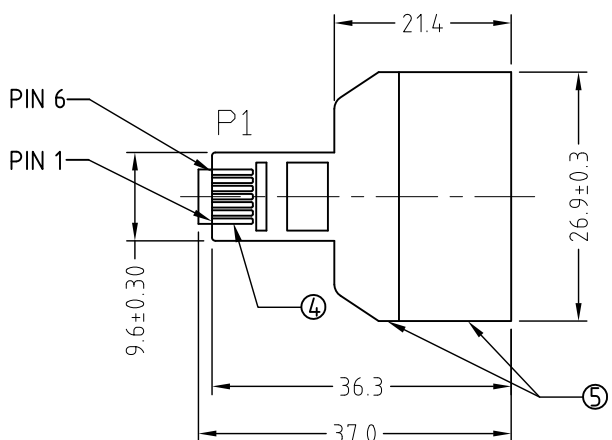
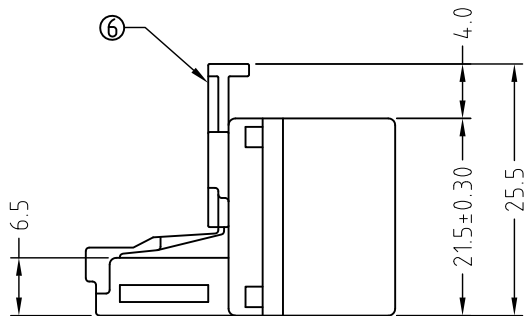

RoHS COMPLIANT

⑦	JACK 6PIN SUPPORT: ABS, IV7 COLOR	2PCS
⑥	SHRAPNEL: ABS, IV7 COLOR, 6PIN.	1PCS
⑤	HOUSING: ABS, IV7 COLOR.	1SET
④	PLUG PIN: GOLD FLASH PLATED.	6PCS
③	JACK TERMINAL: BRASS.	12PCS
②	JACK PIN: 3U" GOLD PLATED.	12PCS
①	WIRE: UL7*0.11*1.05, L=100mm.	6PCS
ITEM	DESC	Q'TY

威納電子 WINPOINT ELECTRONIC CORP. www.winpoint.com.tw		Title 名稱 Dual Jack Adapter 6P6C				
DR: 制圖 Lijunhua	CHK'D 審核 Taoshaw	APP'D 核准 Wang	REV. AO	UNIT mm [INCH]	SHEET 1/1	
PART NUMBER 威納料號 3296-6P6Cx2-3U	CUSTOMER P/N 客戶料號 -	DATE 日期 Aug.27,09'	GENERAL TOLERANCE 一般公差 MM .XX = ±0.38 .X.XX = ±0.18 .XX.XX = ±0.05 INCH .XX = ±0.015 .XXX = ±0.007 .XXXX = ±0.0020 UNLESS OTHERWISE SPECIFIED			
DWG NO. 圖號 WP009-1010762-B	FILENAME 路徑 WP/009	SCALE 比例 N/A	ANGULAR ±3°			

A4

CUSTOMER DRAWING